

Operation Manual

Sewing Machine

Product Code: 888-X03/X13/X23

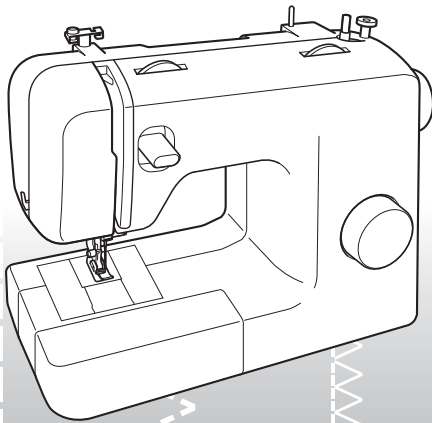

Be sure to read this document before using the machine.
We recommend that you keep this document nearby for future reference.

IMPORTANT SAFETY INSTRUCTIONS

Please read these safety instructions before attempting to use the machine.

! DANGER - To reduce the risk of electric shock:

1 Always unplug the machine from the electrical outlet immediately after using, when cleaning, when making any user servicing adjustments mentioned in this manual, or if you are leaving the machine unattended.

! WARNING - To reduce the risk of burns, fire, electric shock, or injury to persons.

2 Always unplug the machine from the electrical outlet when making any adjustments mentioned in the instruction manual:

- To unplug the machine, switch the machine to the symbol "O" position to turn it off, then grasp the plug and pull it out of the electrical outlet. Do not pull on the cord.
- Plug the machine directly into the electrical outlet. Do not use an extension cord.
- Always unplug your machine if the power is cut.

3 Never operate this machine if it has a damaged cord or plug, if it is not working properly, if it has been dropped or damaged, or water is spilled on the unit. Return the machine to the nearest authorized dealer or service center for examination, repair, electrical or mechanical adjustment.

- While the machine is stored or in use if you notice anything unusual, such

as an odor, heat, discoloration or deformation, stop using the machine and immediately unplug the power cord.

- When transporting the machine, be sure to carry it by its handle. Lifting the machine by any other part may damage the machine or result in the machine falling, which could cause injuries.
- When lifting the machine, be careful not to make any sudden or careless movements, otherwise you may injure your back or knees.

4 Always keep your work area clear:

- Never operate the machine with any air openings blocked. Keep ventilation openings of the machine and foot control free from the build up of lint, dust, and loose cloth.
- Do not store objects on the foot controller.
- Do not use extension cords. Plug the machine directly into the electrical outlet.
- Never drop or insert any object into any opening.
- Do not operate where aerosol (spray) products are being used or where oxygen is being administered.
- Do not use the machine near a heat source, such as a stove or iron; otherwise, the machine, power cord or garment being sewn may ignite, resulting in fire or an electric shock.
- Do not place this machine on an unstable surface, such as an unsteady or slanted table, otherwise the machine may fall, resulting in injuries.

5 Special care is required when sewing:

- Always pay close attention to the needle. Do not use bent or damaged needles.
- Keep fingers away from all moving parts. Special care is required around the machine needle.

- Do not turn on the machine while pressing down the foot controller. The machine may start unexpectedly and cause personal injury or damage to the machine.
- Switch the machine to the symbol “O” position to turn it off when making any adjustments in the needle area.
- Do not use a damaged or incorrect needle plate, as it could cause the needle to break.
- Do not push or pull the fabric when sewing, and follow careful instruction when freehand stitching so that you do not deflect the needle and cause it to break.

6 This machine is not a toy:

- Your close attention is necessary when the machine is used by or near children.
- The plastic bag that this machine was supplied in should be kept out of the reach of children or disposed of. Never allow children to play with the bag due to the danger of suffocation.
- Do not use outdoors.

7 For a longer service life:

- When storing this machine, avoid direct sunlight and high humidity locations. Do not use or store the machine near a space heater, iron, halogen lamp, or other hot objects.
- Use only neutral soaps or detergents to clean the case. Benzene, thinner, and scouring powders can damage the case and machine, and should never be used.
- Always consult the operation manual when replacing or installing any assemblies, the presser feet, needle, or other parts to assure correct installation.

8 For repair or adjustment:

- If the Light unit (light-emitting diode) is damaged, it must be replaced by authorized dealer.
- In the event a malfunction occurs or adjustment is required, first follow the troubleshooting table in the back of

the operation manual to inspect and adjust the machine yourself. If the problem persists, please consult your local authorized Brother dealer.

Use this machine only for its intended use as described in this manual.

Use accessories recommended by the manufacturer as contained in this manual.

The contents of this manual and specifications of this product are subject to change without notice.

For additional product information, visit our web site at www.brother.com

SAVE THESE INSTRUCTIONS

This machine is intended for household use.

FOR USERS IN COUNTRIES EXCEPT CENELEC COUNTRIES

This appliance is not intended for use by persons (including children) with reduced physical, sensory or mental capabilities, or lack of experience and knowledge, unless they have been given supervision or instruction concerning use of the appliance by a person responsible for their safety.

Children should be supervised to ensure that they do not play with the appliance.

FOR USERS IN CENELEC COUNTRIES

This appliance can be used by children aged from 8 years and above and persons with reduced physical, sensory or mental capabilities or lack of experience and knowledge if they have been given supervision or instruction concerning use of the appliance in a safe way and understand the hazards involved. Children shall not play with the appliance. Cleaning and user maintenance shall not be made by children without supervision.

FOR USERS IN THE UK, EIRE, MALTA AND CYPRUS ONLY IMPORTANT

- In the event of replacing the plug fuse, use a fuse approved by ASTA to BS 1362, i.e. carrying the  mark, rating as marked on plug.

- Always replace the fuse cover. Never use plugs with the fuse cover omitted.
- If the available electrical outlet is not suitable for the plug supplied with this equipment, you should contact your authorized dealer to obtain the correct lead.

CONTENTS

IMPORTANT SAFETY INSTRUCTIONS	1	Sewing with a twin needle (Option)	24
1. KNOWING YOUR SEWING MACHINE	4	Thread tension	26
ACCESSORIES	4	3. BUILT-IN STITCHES	27
Optional accessories	4	Straight stitching	27
THE MAIN PARTS	5	Zigzag stitching	27
Flat bed attachment	5	Blind hem stitching	27
USING YOUR SEWING MACHINE	6	Shell tuck stitching	29
Connecting plugs	6	Elastic stitching	29
Main power and sewing light switch	7	Double action stitching	30
Foot controller	7	Fagoting	30
Checking the needle	7	Overedge stitching	31
Replacing the needle	7	Feather stitching	31
Changing the presser foot	8	Triple zigzag stretch stitching	32
THE CONTROLS	9	Decorative stitching	32
Pattern selection dial	9	4. SEWING BUTTONHOLES AND BUTTONS	33
Stretch stitching	9	Making a buttonhole	33
Patterns and stitch names	10	Adjusting buttonholes	34
Stitch length dial	11	Sewing buttons	35
Reverse sewing lever	11	5. USING ATTACHMENTS AND APPLICATIONS	36
THREADING THE MACHINE	12	Zipper insertion	36
Winding the bobbin	12	Gathering	37
Lower threading	14	Darning	37
Lower threading (for models equipped with a quick-set bobbin)	15	Appliqués	37
Upper threading	16	OPTIONAL ACCESSORIES	38
Using the needle threader (for models equipped with a needle threader)	18	Using the blind stitch foot	38
Drawing up the lower thread	19	6. APPENDIX	40
FABRIC, THREAD, AND NEEDLE COMBINATIONS	21	MAINTENANCE	40
2. SEWING BASICS	22	Restrictions on oiling	40
Please read before sewing	22	Precautions on storing the machine	40
Starting sewing	22	Cleaning	40
Trial sewing	23	TROUBLESHOOTING	42
Changing the sewing direction	23	INDEX	45
Sewing thick fabrics	23		
Sewing thin fabrics	24		
Sewing stretch fabrics	24		
Stitching cylindrical pieces	24		

1 KNOWING YOUR SEWING MACHINE

1

ACCESSORIES

We have designed these accessories to help you easily perform most sewing tasks.

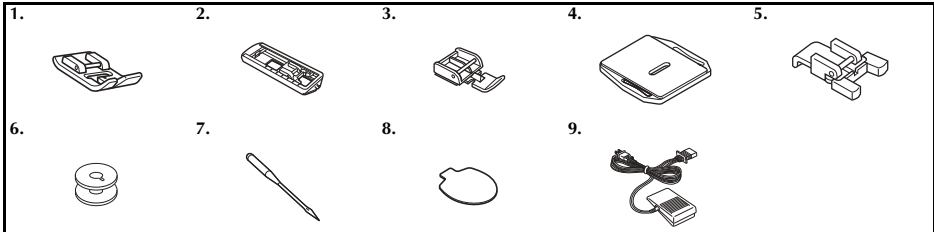

No.	Part Name	Part Code	
		Americas	Others
1	Zigzag foot "J" (on machine)	XC4901-121	
2	Buttonhole foot "A"	X59369-321	
3	Zipper foot "I"	XE9369-001	
4	Darning Plate	XC6063-021	
5	Button sewing foot "M"	XE2137-001	

No.	Part Name	Part Code	
		Americas	Others
6	Bobbin (One is on machine)	SA156	SFB: XA5539-151
7	Needle set (90/14 needle)	3-piece set: XE5328-001 2-piece set: XE7064-001	
8	Oval screwdriver	XE5241-001	
9	Foot controller	See page 5	



Note

- The included accessories vary depending on the machine model.

Optional accessories

The following are available as optional accessories to be purchased separately. Depending on the model you purchased, the following accessory may be included with your machine.

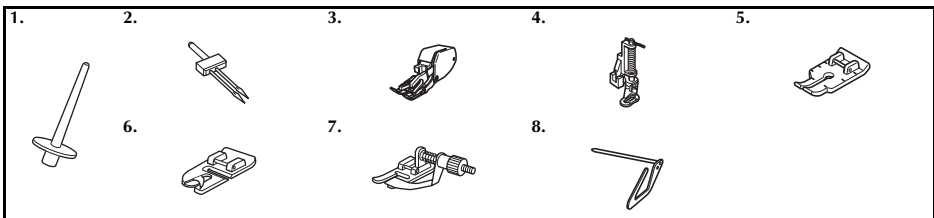

No.	Part Name	Part Code	
		Americas	Others
1	Extra spool pin	XE2241-001	
2	Twin needle (2.0/75 needle)	X57521-021	
3	Walking Foot	SA107	F034N: XC2165-002
4	Quilting Foot	SA129	F005N: XC1948-052

No.	Part Name	Part Code	
		Americas	Others
5	1/4-inch Quilting Foot	SA125	F001N: XC1944-052
6	Narrow Hemmer Foot	SA127	F003N: XC1945-052
7	Blind Stitch Foot	SA134	F018N: XC1976-052
8	Quilting guide	SA132	F016N: XC2215-052

THE MAIN PARTS

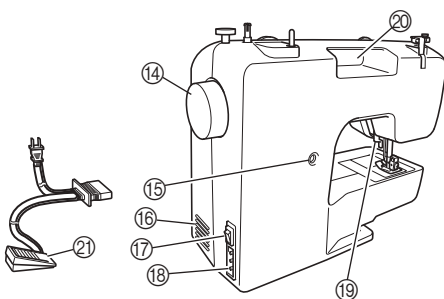
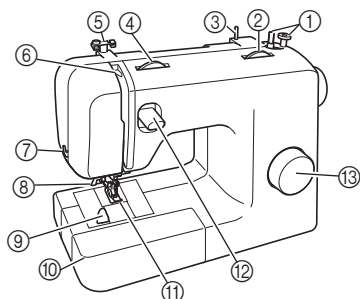

- ① **Bobbin winder (Page 2)**
This winds the thread onto the bobbin for use as the lower thread.
- ② **Stitch length dial (Page 11)**
Rotate the dial to control the stitch length.
- ③ **Spool pin (Page 12, 16)**
This holds the spool of thread.
- ④ **Upper tension-control dial (Page 26)**
This controls the tension of the upper thread.
- ⑤ **Thread guide (Page 12, 16)**
This is used when winding the thread onto the bobbin and then threading the machine.
- ⑥ **Thread take-up lever (Page 17)**
- ⑦ **Thread cutter (Page 23)**
Pass the threads through the thread cutter to cut them.
- ⑧ **Needle threader (Page 18)**
(This is only available on certain models.)
- ⑨ **Quick-set bobbin (Page 15, 20)**
(This is only available on certain models.)
- ⑩ **Flat bed attachment with accessory compartment (Page 5)**
- ⑪ **Presser foot (Page 8)**
- ⑫ **Reverse sewing lever (Page 11)**
Push this lever to stitch in the reverse direction.
- ⑬ **Pattern selection dial (Page 9)**
Rotate the dial in either direction to choose the stitch you want.
- ⑭ **Handwheel**
Used to manually raise and lower the needle.
- ⑮ **Buttonhole fine-adjustment screw (Page 34)**
- ⑯ **Air vent**
Do not cover the air vent while the machine is being used.
- ⑰ **Main power and sewing light switch (Page 7)**
You can turn the main power and sewing light switch on and off.

- ⑱ **Foot controller jack / socket (Page 6)**
Plug in the foot controller plug and connect the machine to the power supply.
- ⑲ **Presser foot lever (Page 16)**
Used to raise and lower the presser foot.
- ⑳ **Handle**
Carry the machine by its handle when transporting.
- ㉑ **Foot controller (Page 7)**
You can use this to control the sewing speed, and to start and stop sewing.

Foot Controller:

Model KD-1902 for 110-120V area

KD-1902 for 110-127V area (Brazil only)

Model KD-2902 for 220-240V area

The foot controller part code differs depending on the country or region. Contact your dealer or the nearest authorized service center.

Flat bed attachment

The accessories can be stored in a compartment inside the flat bed attachment.

- 1 **Slide the flat bed attachment to the left to open it.**

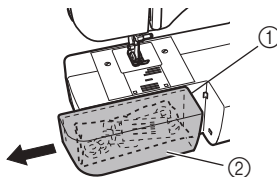

- ① Flat bed attachment
- ② Storage compartment

USING YOUR SEWING MACHINE

1

! WARNING

- Use only regular household electricity for the power source. Using other power sources may result in fire, electric shock, or damage to the machine.
- Make sure that the plugs on the power cord are firmly inserted into the electrical outlet and the power supply jack on the machine.
- Do not insert the plug on the power cord into an electrical outlet that is in poor condition.
- Turn off the main power and remove the plug in the following circumstances:
 - When you are away from the machine
 - After using the machine
 - When the power fails during use
 - When the machine does not operate correctly due to a bad connection or a disconnection
 - During electrical storms

! CAUTION

- Use only the power cord included with this machine.
- Do not use extension cords or multi-plug adapters with many other appliances plugged in to them. Fire or electric shock may result.
- Do not touch the plug with wet hands. Electric shock may result.
- When unplugging the machine, always turn off the main power first. Always grasp the plug to remove it from the outlet. Pulling on the cord may damage the cord, or lead to fire or electric shock.
- Do not allow the power cord to be cut, damaged, modified, forcefully bent, pulled, twisted, or bundled. Do not place heavy objects on the cord. Do not subject the cord to heat. These things may damage the cord and cause fire or electric shock. If the cord or plug is damaged, take the machine to your authorized dealer for repairs before continuing use.
- Unplug the power cord if the machine is not to be used for a long period of time. Otherwise a fire may result.

Connecting plugs

- 1 Connect the foot controller plug to the machine.
- 2 Connect the power supply plug to a wall outlet.

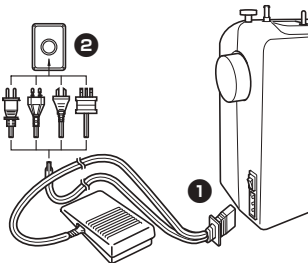

☀ Note

- If a power outage occurs while the sewing machine is being operated, turn off the main power and unplug the power supply cord. When restarting the sewing machine, follow the necessary procedure to correctly operate the machine.

(For U.S.A. only)

- This appliance has a polarized plug (one blade wider than the other). To reduce the risk of electric shock, this plug is intended to fit in a polarized outlet only one way. If the plug does not fit fully in the outlet, reverse the plug. If it still does not fit, contact a qualified electrician to install the proper outlet. Do not modify the plug in any way.

Main power and sewing light switch

This switch turns the main power and sewing light on or off.

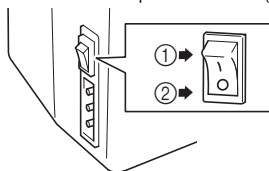

- ① Turn on (toward the 'I' mark)
- ② Turn off (toward the 'O' mark)

CAUTION

- Do not turn on the machine while pressing down the foot controller. The machine may start unexpectedly and cause personal injury or damage to the machine.

Foot controller

When you press the foot controller down lightly, the machine will run at a low speed. When you press harder, the machine's speed will increase. When you take your foot off the foot controller, the machine will stop.

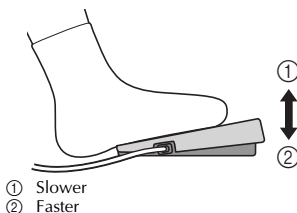

You should make sure that nothing is placed on the foot controller when the machine is not in use.

CAUTION

- Do not allow pieces of cloth and dust to build up on the foot controller. Doing so could cause a fire or an electric shock.



Note

(For U.S.A. only)

- Foot Controller: Model KD-1902
This foot controller can be used on the machine with product code 888-X03, 888-X13 and 888-X23.
The product code is mentioned on the machine rating plate.

Checking the needle

The sewing needle must always be straight and sharp for smooth sewing.

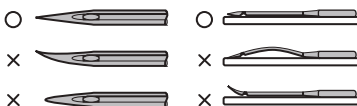

Checking the needle correctly

Put the flat side of the needle on a flat surface. Check the needle from the top and the sides. Dispose of any bent needles safely.

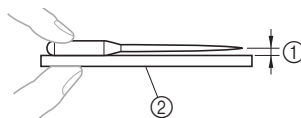

- ① Parallel space
- ② Level surface (bobbin cover, glass, etc.)

Replacing the needle

CAUTION

- Always turn off the machine before you change the needle. Otherwise, injuries may occur if the foot controller is accidentally pressed and the machine starts sewing.
- Only use sewing machine needles for home use. Other needles may bend or break and cause injury.
- Never sew with a bent needle. A bent needle will easily break and cause injury.

- 1 Turn off the machine.
- 2 Raise the needle by turning the handwheel toward you (counterclockwise) so that the mark on the wheel points up.
- 3 Lower the presser foot lever.

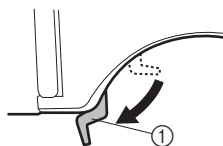

- ① Presser foot lever

! CAUTION

- Before replacing the needle, place fabric or paper under the presser foot to prevent the needle from falling into the hole in the needle plate.

4 Hold the needle with your left hand, and then use an oval screwdriver to turn the needle clamp screw counterclockwise to remove the needle.

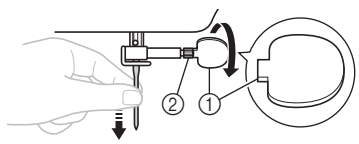

- ① Use an oval screwdriver
 - ② Needle clamp screw
- Do not use excessive force when loosening or tightening the needle clamp screw, otherwise certain parts of the sewing machine may be damaged.

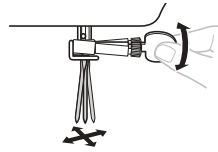

5 With the flat side of the needle toward the back of the machine, insert the needle until it touches the needle stopper. Next, tighten the needle clamp using an oval screwdriver.

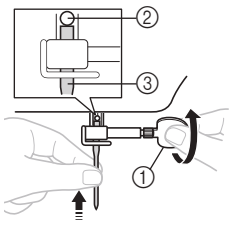

- ① Use an oval screwdriver
- ② Needle stopper
- ③ Needle

Install the twin needle in the same way.

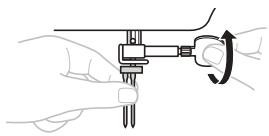

! CAUTION

- Make sure you insert the needle until it touches the stopper, and securely tighten the needle clamp screw with an oval screwdriver, otherwise the needle may break or the machine may be damaged.

Changing the presser foot

! CAUTION

- Always turn off the machine before you change the presser foot. If you leave the power on and step on the controller, the machine will start and you may be injured.
- Always use the correct presser foot for the stitch pattern you have chosen. If you use the wrong presser foot, the needle may strike the presser foot and bend or break, and may cause injury.
- Only use presser feet that have been designed to be used with this machine. Using any other presser foot may cause accident or injury.

You will have to change the presser foot depending on what you want to sew and how.

- 1** Turn off the machine. Raise the presser foot lever.
- 2** Raise the needle by turning the handwheel toward you (counterclockwise) so that the mark on the wheel points up.
- 3** Press the black button at the back of the presser foot holder to release the presser foot.

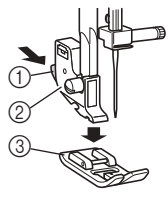

- ① Black button
- ② Presser foot holder
- ③ Presser foot

4 Put a different presser foot on the needle plate so that the bar on the presser foot is in line with the slot on the shank.

- 5** Lower the presser foot lever and fix the presser foot onto the shank. If the presser foot is in the correct place, the bar should snap in.

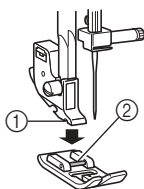

- ① Shank
- ② Bar

■ Presser foot installation orientation

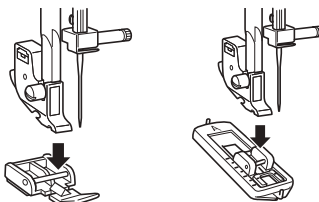

! CAUTION

- If the presser foot is not installed with the correct orientation, the needle may strike the presser foot, which may bend or break the needle and cause injury.

THE CONTROLS

Pattern selection dial

! CAUTION

- When you use the pattern selection dial to choose a pattern, raise the needle by turning the handwheel toward you (counterclockwise) so that the mark on the wheel points up. If the needle is in the down position when you turn the pattern selection dial, the needle, presser foot or fabric may be damaged.

To choose a stitch, simply turn the pattern selection dial in either direction. The next section shows recommended stitch lengths.

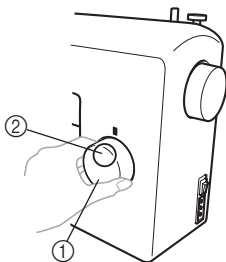

- ① Pattern selection dial
- ② Chosen pattern number

Stretch stitching

Raise the needle by turning the handwheel toward you (counterclockwise) so that the mark on the wheel points up.



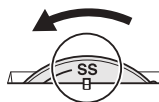



Setting the stitch length dial to “SS” changes the selected pattern to a stretch stitch.

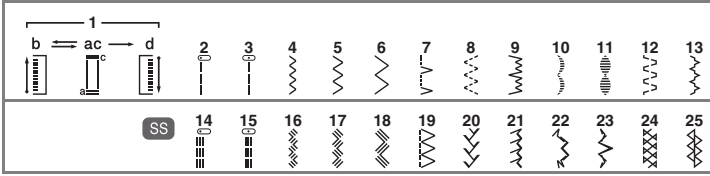

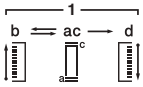

















Patterns and stitch names

■ 25 Stitches



Pattern	Recommended Length (mm (inch))	Reference Page
Stitch Name	Preset Width (mm (inch))	
 4-STEP AUTOMATIC BUTTONHOLE	F-1.5 (1/64-1/16) 5 (3/16)	33
 STRAIGHT STITCH (Left Needle Position)	1-4 (1/16-3/16) —	
 STRAIGHT STITCH (Center Needle Position)	1-4 (1/16-3/16) —	27, 36, 37, 38
 ZIGZAG STITCH	F-4 (1/64-3/16) 1.5 (1/16)	
 ZIGZAG STITCH	F-4 (1/64-3/16) 3.5 (1/8)	27, 35, 37, 38
 ZIGZAG STITCH	F-4 (1/64-3/16) 5 (3/16)	
 SHELL TUCK STITCH	F-3 (1/64-1/8) 5 (3/16)	29

Pattern	Recommended Length (mm (inch))	Reference Page
Stitch Name	Preset Width (mm (inch))	
 ELASTIC STITCH	F-2.5 (1/64-3/32) 5 (3/16)	29
 STRETCH BLIND HEM STITCH	F-1.5 (1/64-1/16) 5 (3/16)	
 SCALLOP STITCH	F-1.5 (1/64-1/16) 5 (3/16)	32
 BEAD STITCH	F-1.5 (1/64-1/16) 5 (3/16)	32
 DOUBLE ACTION STITCH	F-3 (1/64-1/8) 5 (3/16)	30
 BRIDGING STITCH	F-3 (1/64-1/8) 5 (3/16)	
 TRIPLE STRETCH STITCH (Left Needle Position)	SS Fixed 2.5 (3/32) —	27

Pattern	Recommended Length (mm (inch))	Reference Page
Stitch Name	Preset Width (mm (inch))	
 15 TRIPLE STRETCH STITCH (Center Needle Position)	SS Fixed 2.5 (3/32)	27
	—	
 16 TRIPLE ZIGZAG STRETCH STITCH	SS Fixed 2.5 (3/32) 1.5 (1/16)	32
 17 TRIPLE ZIGZAG STRETCH STITCH	SS Fixed 2.5 (3/32) 3.5 (1/8)	32
 18 TRIPLE ZIGZAG STRETCH STITCH	SS Fixed 2.5 (3/32) 5 (3/16)	32
 19 ELASTIC OVERLOCK STITCH	SS Fixed 2.5 (3/32) 5 (3/16)	31
 20 FEATHER STITCH	SS Fixed 2.5 (3/32) 5 (3/16)	31
 21 COMB STITCH	SS Fixed 2.5 (3/32) 5 (3/16)	31
 22 DECORATIVE STITCH	SS Fixed 2.5 (3/32) 5 (3/16)	32
 23 DECORATIVE STITCH	SS Fixed 2.5 (3/32) 5 (3/16)	32
 24 FAGOTING STITCH	SS Fixed 2.5 (3/32) 5 (3/16)	30
 25 DECORATIVE STITCH	SS Fixed 2.5 (3/32) 5 (3/16)	30

Stitch length dial

Depending on the selected stitch, you may need to adjust the stitch length for best results.

The numbers marked on the stitch length dial represent the stitch length in millimeters (mm) (1/25 inch).

THE HIGHER THE NUMBER, THE LONGER THE STITCH. With the “0” setting, material is not fed. This is used when sewing a button.

The “F”-“1” range is for making a satin stitch (closed zigzag stitch), which is used for making buttonholes and decorative stitches. The position needed for making the satin stitch varies according to the material and thread being used. To determine the exact dial position, first test the stitch and length settings on a scrap piece of fabric to observe the feeding of the material.

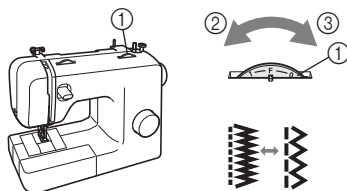

- ① Stitch length dial
- ② Shorter
- ③ Longer

CAUTION

- If the stitches are bunched together, lengthen the stitch length and continue sewing. Do not continue sewing without lengthening the stitch length, otherwise the needle may break and cause injury.

Reverse sewing lever

You can use reverse sewing for back tacking and reinforcing seams.

To sew in reverse, push the reverse sewing lever in as far as possible and hold it in that position while you lightly push the foot controller. To sew forward, release the reverse sewing lever. The machine will then sew forward.

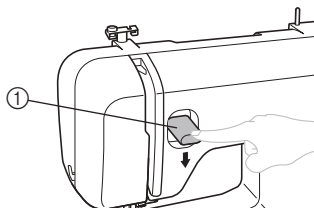

- ① Reverse sewing lever

THREADING THE MACHINE

Winding the bobbin

! CAUTION

- We designed the bobbin that comes with this machine. If you use bobbins from other models, the machine will not work properly. Only use the bobbin that comes with this machine or bobbins of the same type (part code: SA156, SFB: XA5539-151). Using other bobbins may cause damage to the machine.

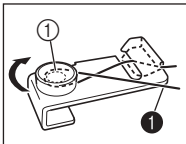
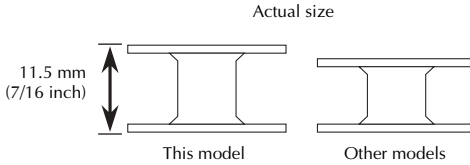

- ① Pull the thread in completely.

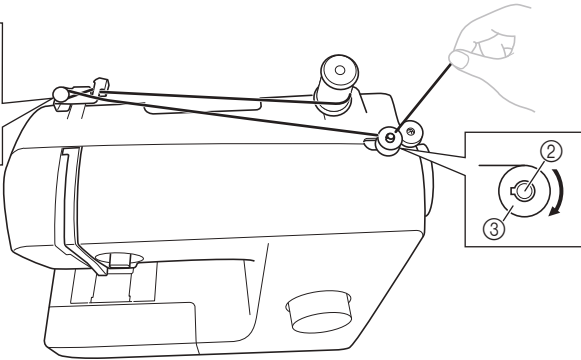

- ① Pre-tension disk
- ② Bobbin winder shaft
- ③ Bobbin

- ① Pull up the spool pin and put a spool of thread on this pin.

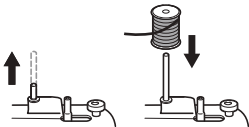

- ② While holding the thread from the spool with your right hand, pass the thread toward you, in the groove on the thread guide. Then, pass the thread around the pre-tension disk and pull the thread in completely.

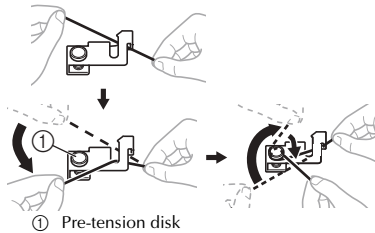

- ① Pre-tension disk

! CAUTION

- If the spool of thread is in the wrong place, or is set incorrectly, the thread may tangle on the spool pin.

- 3** Pass the end of the thread through the hole on the bobbin from the inside of the bobbin.

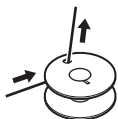

- 4** Put the bobbin onto the bobbin winder shaft and slide the bobbin winder shaft to the right. Turn the bobbin clockwise, by hand, until the spring on the shaft slides into the notch of the bobbin.

- Make sure to pull out 7 to 10 cm (3-4 inches) of thread from the hole on the bobbin.

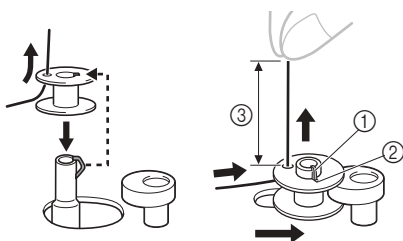

- ① Spring on the shaft
- ② Notch
- ③ 7-10 cm (3 – 4 inches)

! CAUTION

- Pull the thread taut and hold the end of the thread straight up. If the thread is too short, not pulled taut or held at an angle, injuries may occur when the thread is wound around the bobbin.

- 5** Turn on the machine.

! CAUTION

- Do not turn on the machine while pressing down the foot controller. The machine may start unexpectedly and cause personal injury or damage to the machine.

- 6** While holding the end of the thread, gently press the foot controller to wind the thread around the bobbin a few times. Then stop the machine.

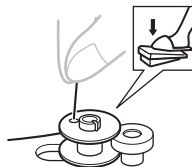

- 7** Trim the excess thread above the bobbin.

- Leave 1 cm (1/2 inch) of thread from the hole on the bobbin.

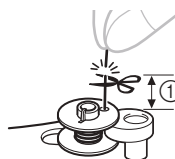

- ① 1 cm (1/2 inch)

! CAUTION

- Make sure you follow the instructions carefully. If you do not cut the excess thread completely before winding the bobbin, when the thread runs low it may tangle around the bobbin and cause the needle to break.

- 8** Press the foot controller to start.

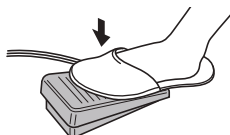

- 9** When the bobbin seems full and begins spinning slowly, take your foot off the foot controller.

- 10** Cut the thread, slide the bobbin winder shaft to the left and remove the bobbin.

Note

- When the sewing machine is started or the handwheel is turned after winding the thread around the bobbin, the machine will make a clicking sound; this is not a malfunction.
- The needle bar does not move when you slide the bobbin winder shaft to the right.

CAUTION

- Not winding the bobbin properly may cause the thread tension to loosen, and may break the needle.



①

- ① Wound evenly



②

- ② Wound poorly

Lower threading

Install the bobbin wound with thread.

- For more details on using the quick-set bobbin, see page 15.

CAUTION

- Make sure you turn off the machine while threading. If you accidentally step on the foot controller and the machine starts to sew, you could be injured.

1 Prepare the bobbin wound properly before threading the lower thread.

- See page 12 for the details about bobbin winding.

2 Raise the needle by turning the handwheel toward you (counterclockwise) and raise the presser foot lever.

3 Remove the bobbin cover by sliding it and lift toward you.

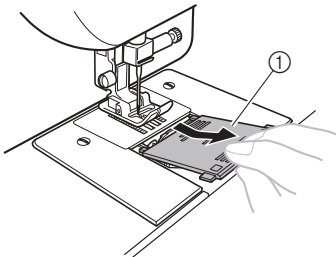

① Bobbin cover

4 Put the bobbin in so the thread comes out in the direction shown by the arrow.

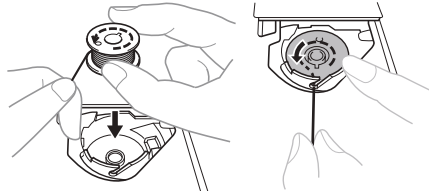

CAUTION

- Make sure you set the bobbin so the thread unrolls in the right direction. If the thread unrolls in the wrong direction, it may cause the thread tension to be incorrect or break the needle.

5 Hold the end of the thread, push the bobbin down with your finger, and then pass the thread through the slit, as shown.

- If the thread is not correctly inserted through the tension-adjusting spring of the bobbin case, it may cause incorrect thread tension.

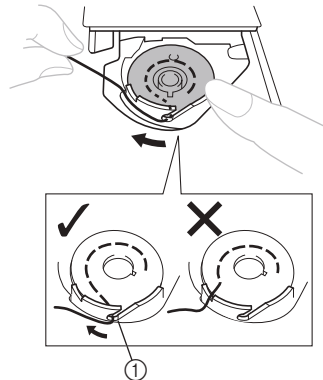

① Tension-adjusting spring

6 Replace the bobbin cover. Put the projection into the race retainer groove and push closed.

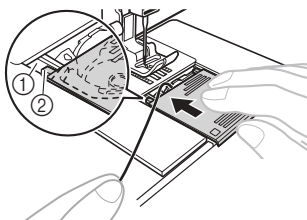

- ① Groove
- ② Projection

- Make sure that the end of the thread comes out from the cover toward the rear of the machine (as shown in the illustration).
- Draw up the lower thread before starting sewing. Refer to “Drawing up the lower thread” on page 19 after threading the upper thread.

Lower threading (for models equipped with a quick-set bobbin)

Install the bobbin wound with thread. This feature is only available on certain models.

1 Follow steps ① to ④ from “Lower threading” on page 14.

2 While lightly holding down the bobbin with your right hand as shown, guide the thread through the slit (①) and (②). Then, pull the thread toward you to cut it with the cutter (③).

- At this time, check that the bobbin easily rotates counterclockwise.

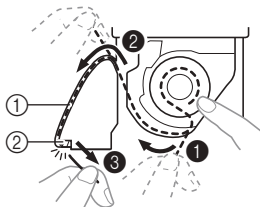

- ① Slit
- ② Cutter (Cut the thread with the cutter.)

Note

- If the thread is not correctly inserted through the tension-adjusting spring of the bobbin case, it may cause incorrect thread tension.

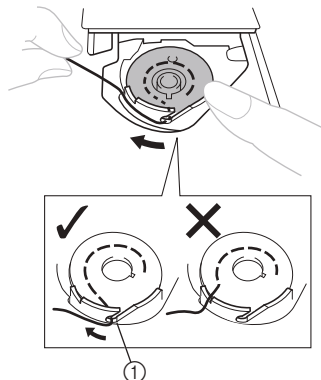

- ① Tension-adjusting spring

3 Replace the bobbin cover. Put the projection into the race retainer groove and push closed.

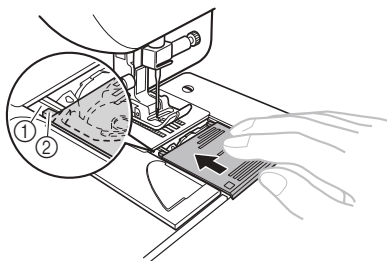

- ① Groove
- ② Projection

- Start sewing after threading the lower and upper thread. When sewing gathers or darts, you can draw up the lower thread by hand so that some thread will be left over. Refer to the steps in “Drawing up the lower thread” (page 19).

Upper threading

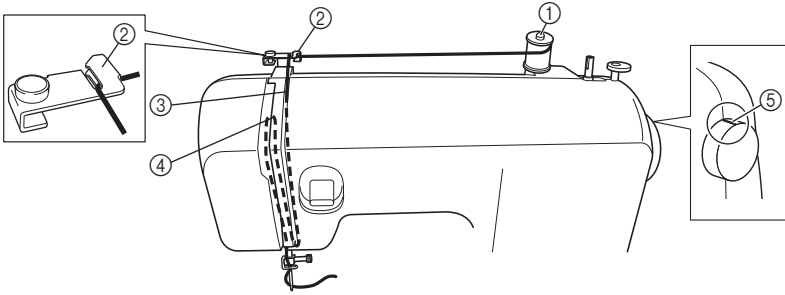

- ① Spool pin
- ② Thread guide (back)
- ③ Thread guide (front)

- ④ Thread take-up lever
- ⑤ Mark on the handwheel

! CAUTION

- When threading the upper thread, carefully follow the instructions. If the upper threading is not correct, the thread may become tangled or the needle may bend or break.
- Never use a thread weight of 20 or lower.
- Use the needle and the thread in the correct combination. For details on the correct combination of needles and threads, refer to "FABRIC, THREAD, AND NEEDLE COMBINATIONS" on page 21.

1 Turn off the machine.

2 Raise the presser foot lever.

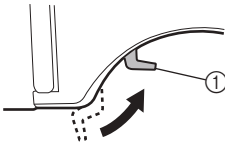

- ① Presser foot lever

3 Raise the needle by turning the handwheel toward you (counterclockwise) so that the mark on the wheel points up.

- If the needle is not correctly raised, the sewing machine can not be threaded.

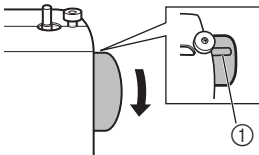

- ① Mark on the wheel

4 Pull up the spool pin and put a spool of thread on this pin.

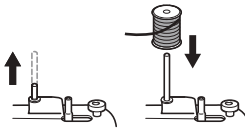

! CAUTION

- If the spool of thread is in the wrong place, or is set incorrectly, the thread may tangle on the spool pin and cause the needle to break.

5 While holding the thread from the spool with your right hand, pass the thread toward you, in the groove on the thread guide.

- Make sure that the spring in the groove catches the thread.

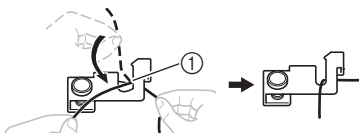

① Spring

6 Feed the upper thread as shown in the following illustration.

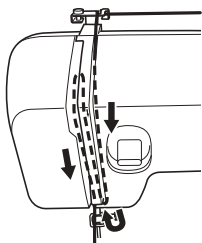

7 Make sure you guide the thread through the thread take-up lever from right to left as shown in the following illustration.

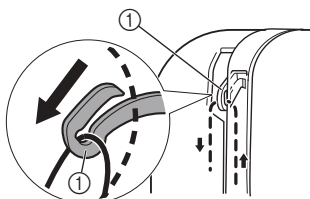

① Thread take-up lever

Memo

- If the thread take-up lever is lowered, the upper thread can not be wrapped around the thread take-up lever. Make sure you raise the needle by turning the handwheel toward you (counterclockwise) so that the mark on the wheel points up.

8 Put the thread behind the guide above the needle.

- The thread can easily be passed behind the needle bar thread guide by holding the thread in your left hand, then feeding the thread with your right hand.

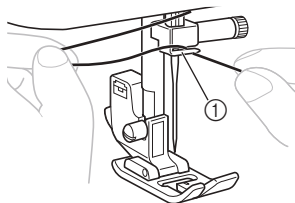

① Needle bar thread guide

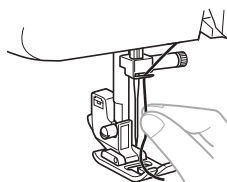

9 Thread the needle from front to back leaving a thread tail of about 5 cm (2 inches).

- If your sewing machine is equipped with a needle threader, use the needle threader to thread the needle (see next section).

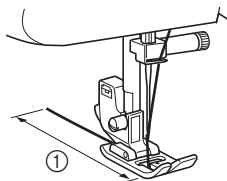

① 5 cm (2 inches)

Note

- Make sure you raise the presser foot lever and the thread take-up lever before you feed the upper thread.
- If you incorrectly feed the thread you may cause sewing problems.

Using the needle threader (for models equipped with a needle threader)

This feature is only available on certain models.

CAUTION

- The needle threader can be used with a 75/11 through 100/16 home sewing machine needle. However, the needle threader cannot be used with a 65/9 home sewing machine needle. When using special thread such as transparent nylon thread or metallic thread, the needle threader cannot be used.
- Thread with a thickness of 130/120 or thicker cannot be used with the needle threader.
- The needle threader cannot be used with the wing needle or the twin needle.
- If the needle threader cannot be used, refer to “Upper threading” on page 16.

- 1 Follow steps 1 to 3 from “Upper threading” on page 16 before using the needle threader.
- 2 Lower the presser foot lever.
- 3 Make sure that the mark on the wheel points up as shown in the following illustration.

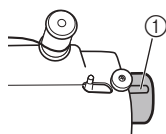

① Mark on the wheel

- 4 While lowering the needle threader lever, hook the thread onto the guide.

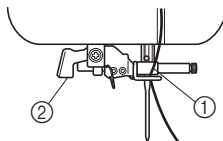

① Needle holder
② Needle threader lever

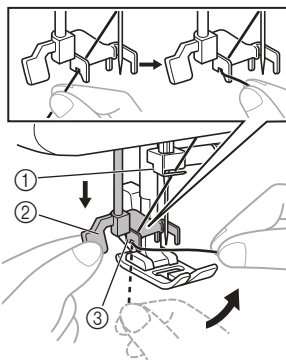

① Needle holder
② Needle threader lever
③ Guide

- 5 Pull down the needle threader lever as much as possible, and then turn the lever toward the back of the machine (away from you). Make sure that the hook passes through the eye of the needle and grabs the thread.

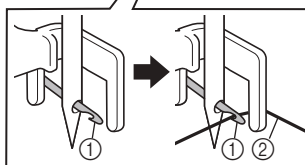
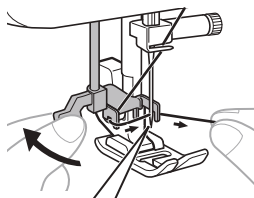

① Hook
② Thread

- Hold the thread in front of the needle to make sure that the hook grabs it.

- 6** While lightly holding the thread, turn the needle threader lever toward the front of the machine (toward you). The hook will pull the thread through the needle.

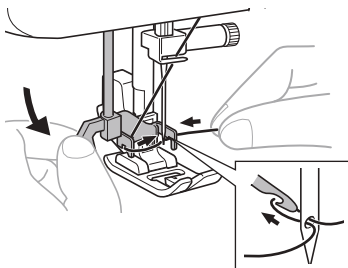

- 7** Raise the needle threader lever.

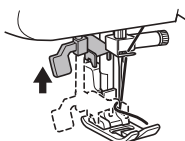

- 8** Pull the loop of the thread passed through the eye of the needle toward the rear of the machine.

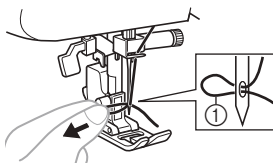

① Loop of thread

CAUTION

- Be careful not to pull on the thread with force or it may bend the needle.
- If the thread does not pass through the eye of the needle, start from step ③ again.

- 9** Raise the presser foot lever.

- 10** Pass the end of the thread through the presser foot, and then pull out about 5 cm (2 inches) of thread toward the rear of the machine.

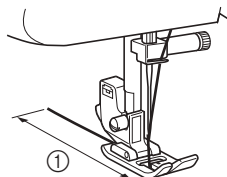

① 5 cm (2 inches)

Note

- If you incorrectly feed the thread you may cause sewing problems.

Drawing up the lower thread

- 1** While lightly holding the end of the upper thread, slowly turn the handwheel toward you (counterclockwise) by hand to lower and then raise the needle.

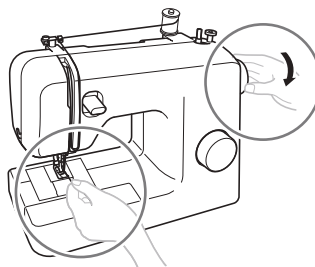

- 2** Pull on the upper thread to draw up the lower thread.

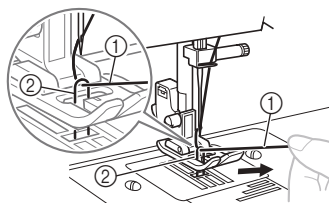

① Upper thread
② Lower thread

- 3** Pull out about 10 cm (4 inches) of both threads and put them toward the back of the machine under the presser foot.

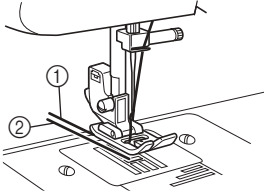

- ① Upper thread
② Lower thread

■ **For models equipped with a quick-set bobbin**

You can begin sewing immediately without drawing up the bobbin thread.

When sewing gathers or darts, you can draw up the lower thread by hand so that some thread will be left over. Before you draw up the lower thread, put the bobbin back in.

- 1** Remove the bobbin cover, and then reinstall the bobbin.
- 2** Pass the thread along the slit in the direction of the arrow, and leave it there without cutting it.

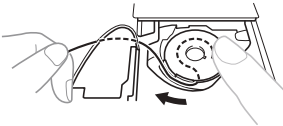

- The bobbin cover should still be removed.

- 3** Draw up the lower thread as described in the previous steps **1** to **3**.
- 4** Replace the bobbin cover.

FABRIC, THREAD, AND NEEDLE COMBINATIONS

Fabric Type/Application		Thread		Size of Needle
		Type	Size	
Medium weight fabrics	Broadcloth	Cotton thread	60–90	75/11–90/14
	Taffeta	Synthetic thread		
	Flannel, Gabardine	Silk thread	50	
Thin fabrics	Lawn	Cotton thread	60–90	65/9–75/11
	Georgette	Synthetic thread		
	Challis, Satin	Silk thread	50	
Thick fabrics	Denim	Cotton thread	30	100/16
			50	90/14–100/16
	Corduroy	Synthetic thread	50–60	
	Tweed	Silk thread		
Stretch fabrics	Jersey	Thread for knits	50–60	Ball point needle 75/11–90/14 (gold colored)
	Tricot			
Easily frayed fabrics		Cotton thread	50–90	65/9–90/14
		Synthetic thread		
		Silk thread	50	
For top-stitching		Synthetic thread	30	100/16
		Silk thread	50–60	75/11–90/14



Note

- Never use a thread weighted #20 or lower. It may cause machine malfunction.



Memo

- The lower the thread number, the thicker the thread; and the higher the needle number, the thicker the needle.

■ Ball point needle

Use the ball point needle when sewing on stretch fabrics or fabrics where skipped stitches easily occur. The factory recommended needle is “HG-4BR” (Organ). Schmetz needles “JERSEY BALL POINT” 130/705H SUK 90/14 may be used as a substitute.

■ Transparent nylon thread

Use a 90/14 to 100/16 needle, regardless of the fabric or thread.



CAUTION

- **Make sure you follow the needle, thread, and fabric combinations listed in the table. Using the wrong combination, such as heavyweight fabric like denim with a small needle (65/9-75/11), may bend or break the needle. The wrong combination may also cause the seam to be uneven, the fabric to pucker, or the machine to skip stitches.**

2 SEWING BASICS

Please read before sewing

! CAUTION

- To avoid being injured, watch the needle carefully while you are using the machine. Keep your hands away from moving parts.
- Do not stretch or pull the fabric during sewing, otherwise the needle may be damaged and you may be injured.
- Do not use bent or broken needles, otherwise you may be injured.
- Take care that the needle does not hit basting pins or other objects during sewing. The needle may break and you may be injured.
- Always use the correct presser foot. If you use the wrong presser foot, the needle may hit the presser foot and bend or break and you may be injured.
- When you turn the handwheel by hand, always turn it toward you (counterclockwise). Turning it the other way may cause the thread to tangle and damage the needle or fabric, and you may be injured.
- Do not start sewing without placing the fabric under the presser foot, otherwise the presser foot may be damaged.

Starting sewing

- 1 Turn on the machine.



! CAUTION

- Do not turn on the machine while pressing down the foot controller. The machine may start unexpectedly and cause personal injury or damage to the machine.

- 2 Raise the needle by turning the handwheel toward you (counterclockwise) so that the mark on the wheel points up.
- 3 Turn the pattern selection dial to select a stitch (see page 9 - 10).
- 4 Change the presser foot (see page 8).

- 5 Raise the presser foot lever.

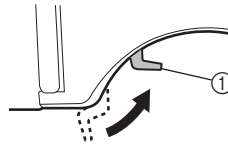

① Presser foot lever

- 6 Place the fabric under the presser foot, pass the thread under the presser foot, and then pull out about 5 cm (2 inches) of thread toward the rear of the machine.

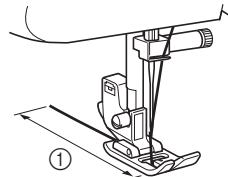

① 5 cm (2 inches)

- 7** While holding the end of the thread and the fabric with your left hand, turn the handwheel toward you (counterclockwise) with your right hand to lower the needle to the starting point of the stitching.



- 8** Lower the presser foot lever.

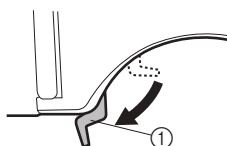

① Presser foot lever

- 9** Slowly press down on the foot controller.

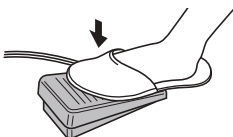

▶ The machine starts sewing.

- 10** Take your foot off the foot controller.

▶ The machine stops sewing.

- You can use reverse sewing for back tacking and reinforcing seams by pressing the reverse sewing lever. Refer to “Reverse sewing lever” on page 11 for the details.

- 11** Raise the needle by turning the handwheel toward you (counterclockwise).

- 12** Raise the presser foot lever.

- 13** Pull the fabric to the left side of the machine, and then pass the threads through the thread cutter to cut them.

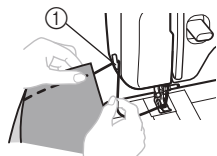

① Thread cutter

Trial sewing

A trial piece of fabric should be sewn. Use a piece of fabric and thread that are the same as those used for your project, and check the thread tension and stitch length and width.

Changing the sewing direction

Stop the machine with the needle in the fabric at the point where you want to change the sewing direction, and then raise the presser foot lever. Using the needle as a pivot, turn the fabric, lower the presser foot lever, and then continue sewing.

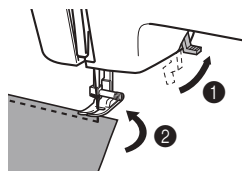

Sewing thick fabrics

- If the fabric does not fit under the presser foot**

If the fabric does not fit easily under the presser foot, raise the presser foot lever even higher to bring the presser foot to its highest position.

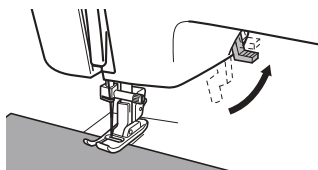

CAUTION

- If fabric more than 6 mm (15/64 inch) thick is sewn or if the fabric is pushed with too much force, the needle may bend or break.

Sewing thin fabrics

When sewing thin fabrics, the stitching may become misaligned or the fabric may not feed correctly. If this occurs, place thin paper or stabilizer material under the fabric and sew it together with the fabric. When you have finished sewing, tear off any excess paper.

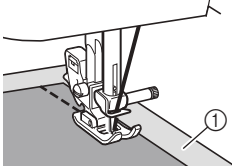

① Stabilizer material or paper

Sewing stretch fabrics

First, baste the pieces of fabric together, and then sew without stretching the fabric.

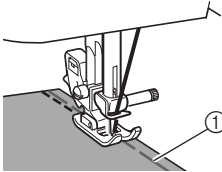

① Basting

Stitching cylindrical pieces

Removing the flat bed attachment makes it easier to sew cylindrical pieces such as cuffs and pant legs, or hard-to-reach areas.

- 1 Slide the flat bed attachment to the left to release it.

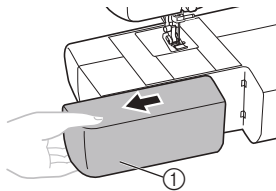

① Flat bed attachment

- ▶ With the flat bed attachment removed, free-arm sewing is possible.

Note

- When you are finished with free-arm sewing, install the flat bed attachment back in its original position.

- 2 Slide the part that you wish to sew onto the arm, and then sew from the top.

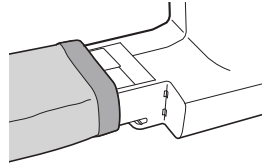

Sewing with a twin needle (Option)

We have designed your machine so you can sew with this needle and two top threads. You can use the same color or two different colors of thread for making decorative stitches.



① Twin needle



② Extra spool pin

CAUTION

- Use only twin needles that have been made for this machine (part code: X57521-021:2.0/75 with a 2 mm width). Other needles could break and damage the machine.
- Make sure that the needle does not strike the presser foot.
- Do not sew with bent needles. The needle could break and injure you.

■ Attaching the twin needle

Attach the twin needle in the same way as a single needle (see page 7–8). The flat side of the needle should face toward the back and the rounded side should face toward you.

■ Attaching the extra spool pin

Insert the extra spool pin onto the end of the bobbin winder shaft. Install the second thread spool onto the extra spool pin.

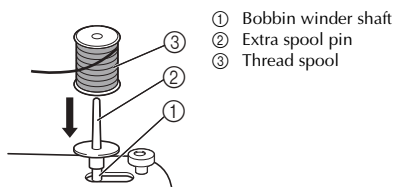

- ① Bobbin winder shaft
- ② Extra spool pin
- ③ Thread spool

■ Twin needle threading

You should thread each needle separately.



Note

Models equipped with a needle threader

- You cannot use the needle threader to thread the twin needle. Instead, thread the twin needle by hand, from front to back. Using the needle threader may damage the machine.

1 Thread the left needle.

Follow the same instructions for threading a single needle (see page 16).

2 Thread the right needle.

Thread the right needle in the same way that you threaded the left needle using the thread from the spool on the extra spool pin, but do not pass the thread through the guide above the needle before you pass it through the eye of the right needle.

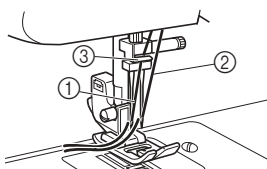

- ① Left needle thread passes through the needle bar thread guide
- ② Right needle thread passes in front of the needle bar thread guide
- ③ Needle bar thread guide

3 Attach zigzag foot “J”.

For details on changing the presser foot, refer to “Changing the presser foot” on page 8.

! CAUTION

- When using the twin needle, be sure to attach zigzag foot “J”, otherwise the needle may break or the machine may be damaged.

4 Turn on the machine.

! CAUTION

- Do not turn on the machine while pressing down the foot controller. The machine may start unexpectedly and cause personal injury or damage to the machine.

5 Select a stitch.

! CAUTION

- After selecting a stitch, slowly turn the handwheel toward you (counterclockwise) and check that the needle does not touch the presser foot. If the needle hits the presser foot, the needle may bend or break.
- The twin needle should only be used with the Straight Stitch (Center Needle Position), the Zigzag Stitch (1.5 mm (1/16 inch)), the Triple Stretch Stitch (Center Needle Position), and the Triple Zigzag Stretch Stitch (1.5 mm (1/16 inch)). Do not use the twin needle with any other stitches.

6

Start sewing.

For details on starting to sew, refer to "Starting sewing" on page 22.

- ▶ Two lines of stitching are sewn parallel to each other.



Note

- When using the twin needle, the stitches may become bunched together, depending on the types of thread and fabric that are used. If this occurs, increase the stitch length. For details on adjusting the stitch length, refer to "Stitch length dial" on page 11.



CAUTION

- **When changing the sewing direction, be sure to raise the needle from the fabric, and then raise the presser foot lever and turn the fabric. Otherwise the needle may break or the machine may be damaged.**

Thread tension

The tension of the thread will affect the quality of your stitches. You may need to adjust it when you change fabric or thread.



Memo

- We recommend that you do a test sample on scrap of a fabric before you start to sew.

Correct tension

Correct tension is important as too much or too little tension will weaken your seams or cause puckers on your fabric.

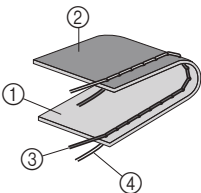

- ① Surface of fabric
- ② Back of fabric
- ③ Upper thread
- ④ Lower thread

Upper tension is too tight

Loops will appear on the surface of the fabric.



Note

- If the bobbin thread was incorrectly threaded, the upper thread may be too tight. In this case, refer to "Lower threading" on page 14 and rethread the bobbin thread.

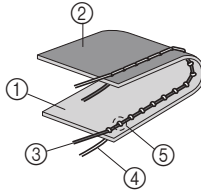

- ① Surface of fabric
- ② Back of fabric
- ③ Upper thread
- ④ Lower thread
- ⑤ Loops appear on surface of fabric

Solution

Reduce the tension by turning the upper tension control dial to a lower number.

Upper tension is too loose

Loops appear on the back of the fabric.



Note

- If the upper thread was incorrectly threaded, the upper thread may be too loose. In this case, refer to "Upper threading" on page 16 and rethread the upper thread.

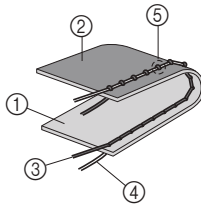

- ① Surface of fabric
- ② Back of fabric
- ③ Upper thread
- ④ Lower thread
- ⑤ Loops appear on back of fabric





Solution

Increase the tension by turning the upper tension control dial to a higher number.

3 BUILT-IN STITCHES

Straight stitching

Straight stitches are used for sewing plain seams.



Stitch Name	Pattern	Stitch Length [mm (inch)]
Straight Stitch (Left Needle Position)		1-4 (1/16-3/16)
Straight Stitch (Center Needle Position)		1-4 (1/16-3/16)
Triple Stretch Stitch (Left Needle Position)		SS Fixed 2.5 (3/32)
Triple Stretch Stitch (Center Needle Position)		SS Fixed 2.5 (3/32)

■ Top stitching and stretch materials

You can use a straight stitch for top stitching and sewing lightweight fabrics.

You can use a triple stretch stitch for sewing stretch fabrics.

Zigzag stitching

Stitch Name	Pattern	Stitch Length [mm (inch)]	Stitch Width [mm (inch)]
Zigzag Stitch		F-4 (1/64-3/16)	1.5 (1/16)
Zigzag Stitch		F-4 (1/64-3/16)	3.5 (1/8)
Zigzag Stitch		F-4 (1/64-3/16)	5 (3/16)

■ Zigzag stitch

Turn the pattern selection dial to the Zigzag Stitch, and then start sewing.

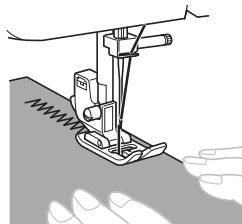

We recommend that you sew using the Straight Stitch at the beginning and end of zigzag stitches. (This acts as a reinforcement stitch.)



■ Satin stitch

Setting the Zigzag Stitch length in the “F”-“1” range produces a satin stitch (close zigzag stitch). The Satin Stitch can be used for making buttonholes and decorative stitches. Set the pattern selection dial to the Zigzag Stitch, set the stitch length in the “F”-“1” range.

Blind hem stitching

Stitch Name	Pattern	Stitch Length [mm (inch)]	Stitch Width [mm (inch)]
Stretch Blind Hem Stitch		F-1.5 (1/64-1/16)	3 (1/8)

You can use the Blind Hem Stitch to finish the edge of a project, like the hem of a pair of trousers, without the stitch showing.

Memo

- When the size of cylindrical pieces is too small to slide onto the arm or the length is too short, the fabric will not feed and desired results may not be achieved.

1 Reverse the skirt or pants.

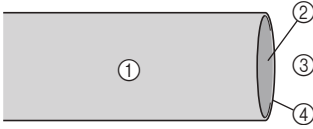

- ① Wrong side of fabric
- ② Right side of fabric
- ③ Bottom side
- ④ Edge of fabric

2 Fold the fabric along the desired edge of the hem, and press.

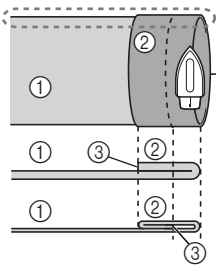

- ① Wrong side of fabric
- ② Right side of fabric
- ③ Edge of fabric
- ④ Desired edge of hem

<Thick fabric>

<Normal fabric>

<Seen from the side>

3 Use a chalk to mark on the fabric about 5 mm (3/16 inch) from the edge of the fabric, and then baste it.

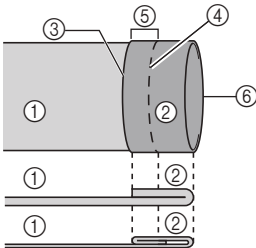

- ① Wrong side of fabric
- ② Right side of fabric
- ③ Edge of fabric
- ④ Basting stitching
- ⑤ 5 mm (3/16 inch)
- ⑥ Desired edge of hem

<Thick fabric>

<Normal fabric>

<Seen from the side>

4 Fold back the fabric inside along the basting.

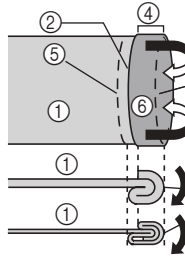

- ① Wrong side of fabric
- ② Edge of fabric
- ③ Basting
- ④ 5 mm (3/16 inch)
- ⑤ Desired edge of hem
- ⑥ Right side of fabric
- ⑦ Basting point

<Thick fabric>

<Normal fabric>

<Seen from the side>

5 Unfold the edge of fabric, and position the fabric with the wrong side facing up.

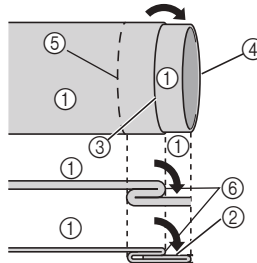

- ① Wrong side of fabric
- ② Right side of fabric
- ③ Basting
- ④ Edge of fabric
- ⑤ Desired edge of hem
- ⑥ Basting point

<Thick fabric>

<Normal fabric>

<Seen from the side>

6 Remove the flat bed attachment and make free-arm sewing possible.

- For details on free-arm sewing, refer to "Stitching cylindrical pieces" (Page 24).

7 Slide the part that you wish to sew onto the arm, make sure that the fabric feeds correctly, and then start sewing.

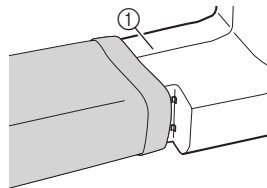

- ① Arm

8 After selecting a stitch, slowly turn the handwheel toward you (counterclockwise) until the needle has moved from the right side to the left.

3

- 9** Position the fabric under the presser foot, and then adjust the fabric position until the needle slightly catches the fold of the hem when the needle comes to the left end of the stitch.

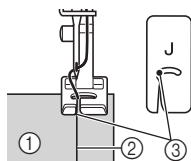

- ① Wrong side of fabric
② Fold of hem
③ Needle drop point

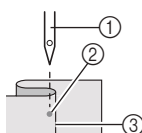

- ① Needle
② Needle drop point
③ Fold of hem

- 10** Lower the presser foot lever.

- 11** Sew at a slow speed holding the fabric with your hands, so that the needle slightly catches the fold of the hem.

- 12** Remove the basting stitching and turn the fabric right side up.

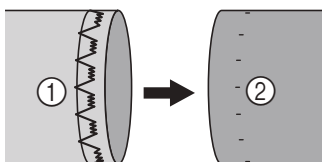

- ① Wrong side of fabric ② Right side of fabric

Shell tuck stitching

Stitch Name	Pattern	Stitch Length [mm (inch)]	Stitch Width [mm (inch)]
Shell Tuck Stitch	7 	F-3 (1/64-1/8)	5 (3/16)

The Shell Tuck Stitch can be used to sew a picot (lace-like) edge on lightweight fabric.

- 1** Adjust the thread tension so that it is tighter than normal.

- 2** Place the fabric under the presser foot so that it will be sewn along the bias, with the straight stitches sewn on the seamline and the zigzag stitches sewn slightly over the folded edge.

- 3** Sew at a slow speed.

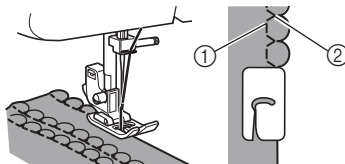

- ① Straight stitches
② Zigzag stitches

Elastic stitching

Stitch Name	Pattern	Stitch Length [mm (inch)]	Stitch Width [mm (inch)]
Elastic Stitch	8 	F-2.5 (1/64-3/32)	5 (3/16)

You can use the Elastic Stitch for mending, sewing elastic or joining fabric. Each is explained below.

■ Mending

- 1** Place the reinforcement fabric under the area you want to mend.

- Use the basting pins to hold the reinforcement fabric.

- 2** Following the line of the tear, sew using the Elastic Stitch as shown.



■ Sewing elastic

- 1 Pin the elastic tape to the wrong side of the fabric.
- 2 As you sew, stretch the elastic in front of and behind the presser foot.

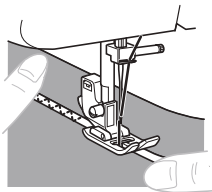

■ Joining fabric

You can use the Elastic Stitch to join two pieces of fabric together and it is very effective when sewing knitted fabrics. If you are using nylon thread, the stitch will not be visible.

- 1 Put the edge of the two pieces of fabric together and center them under the presser foot.
- 2 Sew them together using the Elastic Stitch. Make sure you keep the two fabric edges close together.
 - Use the basting pins to hold the two fabric edges close together.

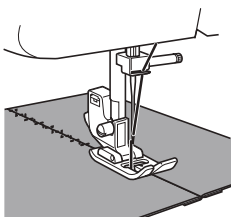

Double action stitching

Stitch Name	Pattern	Stitch Length [mm (inch)]	Stitch Width [mm (inch)]
Double Action Stitch	12 	F-3 (1/64-1/8)	5 (3/16)
Bridging Stitch	13 	F-3 (1/64-1/8)	5 (3/16)

These stitches are used for joining two pieces of fabric, such as when making patchwork.

Example: Patchwork with Double Action Stitch

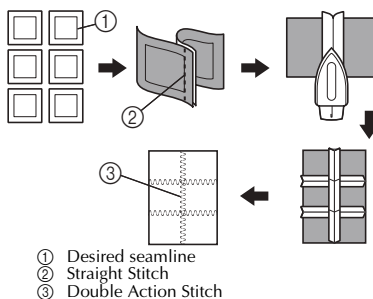

Fagoting

Stitch Name	Pattern	Stitch Length [mm (inch)]	Stitch Width [mm (inch)]
Fagoting Stitch	24 	SS Fixed 2.5 (3/32)	5 (3/16)
Decorative Stitch	25 	SS Fixed 2.5 (3/32)	5 (3/16)

These stitches are used to join two pieces of fabric while leaving a space between their edges. This stitch is more decorative when thicker thread is used.

- 1 Use an iron to fold the two pieces of fabric along their seams.

- 2** Baste the two pieces of fabric, separated by about 2 mm (1/16 inch), onto thin paper or a sheet of water-soluble stabilizer.

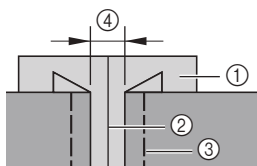

- ① Thin paper or water soluble stabilizer
- ② Draw a line down the middle
- ③ Basting stitching
- ④ 2 mm (1/16 inch)

- 3** Sew with the center of the presser foot aligned along the center of the two pieces of fabric.

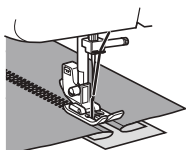

- 4** After sewing is finished, remove the paper and the basting stitches.

Overedge stitching

Stitch Name	Pattern	Stitch Length [mm (inch)]	Stitch Width [mm (inch)]
Elastic Overlock Stitch	19	SS Fixed 2.5 (3/32)	5 (3/16)
Comb Stitch	21	SS Fixed 2.5 (3/32)	5 (3/16)

These stitches are used to join together seams and finish them in one operation. Elastic Overlock Stitch: for sewing stretch materials.

- 1** Put the fabric under the presser foot so that the seamline (or arrowhead point) is approximately 3 mm (1/8 inch) to the left of the center of the presser foot.

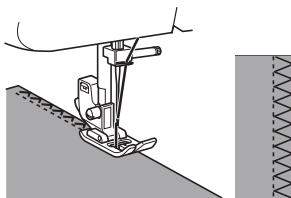

- If the seam allowance is wider than the stitch pattern, trim away any excess fabric after stitching.

Feather stitching



Stitch Name	Pattern	Stitch Length [mm (inch)]	Stitch Width [mm (inch)]
Feather Stitch	20	SS Fixed 2.5 (3/32)	5 (3/16)

Use the Feather Stitch as a decorative top stitch when embroidering or when hemming blankets, tablecloths, or draperies.

- 1** Place the fabric right side up and sew 1 cm (1/2 inch) from the edge of the fabric.
- 2** Trim close to the stitching. The stitch will prevent the fabric from unravelling.





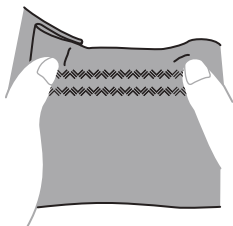

Triple zigzag stretch stitching

Stitch Name	Pattern	Stitch Length [mm (inch)]	Stitch Width [mm (inch)]
Triple Zigzag Stretch Stitch	16 	SS Fixed 2.5 (3/32)	1.5 (1/16)
Triple Zigzag Stretch Stitch	17 	SS Fixed 2.5 (3/32)	3.5 (1/8)
Triple Zigzag Stretch Stitch	18 	SS Fixed 2.5 (3/32)	5 (3/16)

This stitch can be used wherever a zigzag stitch would be used to sew heavyweight stretch fabrics. The Triple Zigzag Stretch Stitch can also be used as a decorative top stitch.



Decorative stitching

Stitch Name	Pattern	Stitch Name	Pattern
Scallop Stitch	10 	Decorative Stitch	22 
Bead Stitch	11 	Decorative Stitch	23 

These stitches can be used for decorative top stitching and for smocking. Refer to page 10 for the stitch width (fixed) and recommended stitch length of each stitches.

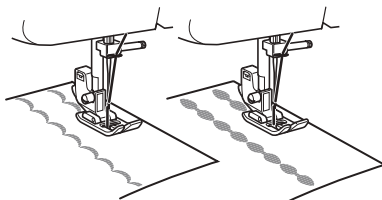

3

4 SEWING BUTTONHOLES AND BUTTONS

! CAUTION

- Always turn off the machine before replacing the presser foot. Otherwise, injuries may occur if the foot controller is accidentally pressed and the machine starts sewing.

Making a buttonhole

Pattern	Stitch Length [mm (inch)]	Stitch Width [mm (inch)]	Foot
	F-1.5 (1/64-1/16)	5 (3/16)	Button-hole Foot "A"

Memo

- We recommend that you practice making a buttonhole on a scrap piece of fabric before you try it on an actual garment.
- When making buttonholes on soft fabrics, place a stabilizer material on the underside of the fabric.

- Using tailor's chalk, mark the position and length of the buttonhole on the fabric.

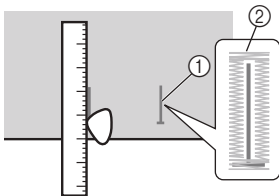

- Marks on fabric
- Buttonhole sewing

- Attach the buttonhole foot and push the frame back until it stops with the plastic insert at the front of the frame.

! CAUTION

- If the presser foot is not installed with the correct orientation, the needle may strike the presser foot, which may bend or break the needle and cause injury. (See page 8 for the correct presser foot orientation.)



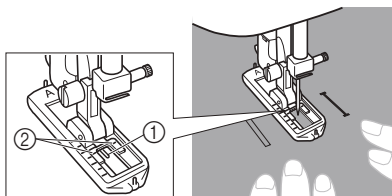

- You need to sew the front bar tack first. Line the bar tack mark under the center of the presser foot and match it up to the two lines on the presser foot.



- Front of chalk mark
- Red lines

■ Making a Buttonhole

Step	Sewn section	Pattern
Step 1 (Front bar tack)		
	<ol style="list-style-type: none"> Set the pattern selection dial to "a". Lower the presser foot and sew 5 to 6 stitches. Stop the machine when the needle is at the left side of the stitches and then raise the needle from the material. 	
Step 2 (Left side)		
	<ol style="list-style-type: none"> Turn the pattern selection dial to "b". Sew the length of the tailor's chalk line. Stop the machine when the needle is at the left side of the stitch and then raise the needle. 	

Step	Sewn section	Pattern
Step 3 (Back bar tack)		
1. Turn the pattern selection dial to "c" (same position as in step 1). 2. Sew 5 to 6 stitches. 3. Stop the machine when the needle is at the right side of the stitch and then raise the needle from the material.		
Step 4 (Right side)		
1. Set the pattern selection dial to "d". 2. Sew the right side until the needle reaches the stitches sewn in step 1.		

■ Securing the Stitching and Cutting the Buttonhole

- 1** To secure the stitching, turn the material 90 degrees counterclockwise and sew straight stitches to the end of the front bar tack of the buttonhole.
- 2** Remove the material from the machine. We recommend that you put pins across both ends of the buttonhole to prevent the stitches from being cut.
- 3** Cut an opening in the middle of the buttonhole with the seam ripper tool. Be careful not to cut through any stitches.

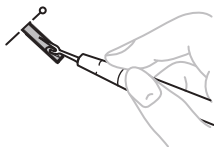

⚠ CAUTION

- When using the seam ripper to open the buttonhole, do not put your hand or finger in the path of the ripper. The seam ripper may slip and you may be injured.

Adjusting buttonholes

If the stitching on the two sides of the buttonhole is not the same, you can make the following adjustments.

- 1** Set the stitch length dial to "F" and "1.5" and sew the buttonhole on a scrap piece of fabric to observe how the material is fed.
- 2** If the right side of the buttonhole is too open or tight, adjust the feeding of the material with the stitch length dial.

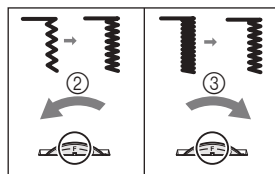

- ① Right side
- ② Shorter
- ③ Longer

- 3** After obtaining a satisfactory feed on the right side, stitch the buttonhole and observe the feeding.
- 4** If the left side is too open or tight compared with the right side, adjust the buttonhole fine-adjustment screw as described in the following paragraphs.

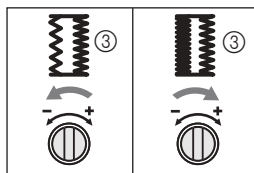
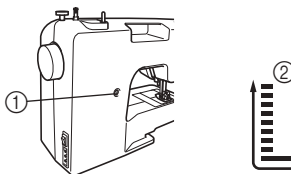

- ① Buttonhole fine-adjustment screw
- ② Left side
- ③ Buttonhole appearance



4

If the left side is too open, turn the buttonhole fine-adjustment screw with a large screwdriver in the “-” direction.

If the left side is too tight, turn the buttonhole fine-adjustment screw with a large screwdriver in the “+” direction.

- This adjustment ensures both sides of the buttonhole are the same.

Sewing buttons

Stitch Name	Pattern	Stitch Length [mm (inch)]	Stitch Width [mm (inch)]	Foot	Other
Zigzag Stitch	4 	F (1/64)	1.5 (1/16)	Button Sewing Foot “M”	Darning Plate
Zigzag Stitch	5 	F (1/64)	3.5 (1/8)	Button Sewing Foot “M”	Darning Plate
Zigzag Stitch	6 	F (1/64)	5 (3/16)	Button Sewing Foot “M”	Darning Plate

- 1 Measure the distance between the buttonholes and set the pattern selection dial to the Zigzag Stitch (1.5 mm, 3.5 mm or 5 mm) with the desired width.



- 2 Turn off the machine.
- 3 Change the foot to the button sewing foot “M”.
- 4 Place the darning plate on the needle plate.

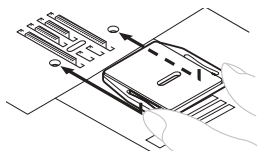

- 5 Turn on the machine.

CAUTION

- Do not turn on the machine while pressing down the foot controller. The machine may start unexpectedly and cause personal injury or damage to the machine.

- 6 Put a button between the foot and the fabric and make sure that the needle enters the holes without hitting the button. If it hits, see step 1.

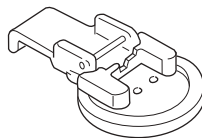

- 7 At a slow speed, sew about 10 stitches.

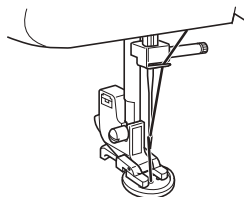

CAUTION

- Make sure the needle does not hit the button during sewing. The needle may break and you may be injured.

- 8 Pull the upper thread at the end of the stitching to the wrong side of the fabric, and then tie it with the bobbin thread.
 - Use scissors to cut the upper thread and the bobbin thread at the beginning of the stitching.

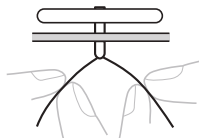

5

USING ATTACHMENTS AND APPLICATIONS

! CAUTION

- Always turn off the machine before replacing the presser foot. Otherwise, injuries may occur if the foot controller is accidentally pressed and the machine starts sewing.

Zipper insertion

Stitch Name	Pattern	Stitch Length [mm (inch)]	Foot
Straight Stitch (Center Needle Position)		2-3 (1/16-1/8)	Zipper Foot "1"

You can use the zipper foot "1" to sew different types of zippers, and can easily position it to the right or left side of the needle.

When sewing with the zipper on the right side, attach the shank to the left pin of the zipper foot. When sewing with the zipper on the left side, attach the shank to the right pin of the zipper foot.

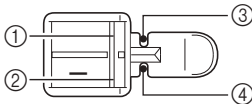

- Right pin for sewing with the zipper on the left side
- Left pin for sewing with the zipper on the right side
- Needle drop point for sewing with the zipper on the left side
- Needle drop point for sewing with the zipper on the right side

1 Prepare the fabric with the zipper basted on the wrong side.

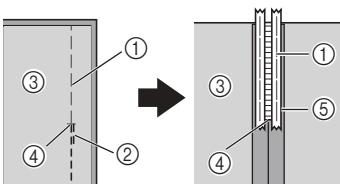

- Basting stitching
- Reverse stitches
- Wrong side of fabric
- End of zipper opening
- Zipper

2 Turn off the machine. Attach the zipper foot "1".

! CAUTION

- Turn the handwheel toward you (counterclockwise) and check that the needle does not touch the zipper foot before you start sewing. Choosing a different stitch will cause the needle to hit the presser foot and break, and you may be injured.

3 Turn on the machine.

! CAUTION

- Do not turn on the machine while pressing down the foot controller.

4 With the right side of the fabric facing up, continue sewing with the zipper on the right side of the presser foot.

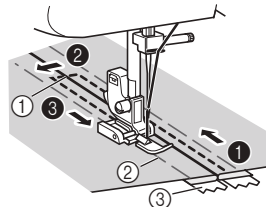



- End of zipper opening
 - Basting stitching
 - Zipper
- Sew the stitching in order, from 1 to 3.

! CAUTION

- Make sure the needle does not hit the zipper during sewing. If the needle hits the zipper, the needle may break and you may be injured.

5 When you have finished sewing, remove the basting stitching.



Gathering

Stitch Name	Pattern	Stitch Length [mm (inch)]
Straight Stitch (Left Needle Position)		4 (3/16)
Straight Stitch (Center Needle Position)		4 (3/16)

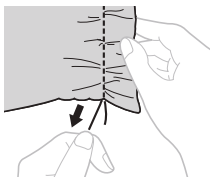
- Loosen the tension of the upper thread so that the lower thread lies on the underside of the material.
- Sew a single row (or many rows) of straight stitches.
- Pull the lower threads to gather the material.



Darning

Stitch Name	Pattern	Stitch Length [mm (inch)]	Other
Straight Stitch (Left Needle Position)		Any	Darning Plate
Straight Stitch (Center Needle Position)		Any	Darning Plate

- Turn off the machine. Place the darning plate on the needle plate.

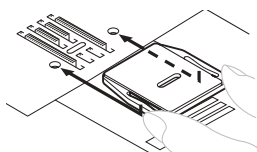

- Either remove both the presser foot and presser foot holder assembly and then lower the presser foot lever.
- Put the section you want to darn under the presser foot together with fabric for reinforcement.
- Turn on the machine.

CAUTION

- Do not turn on the machine while pressing down the foot controller.

- Begin sewing by alternating between gently drawing the work away from you and pulling it toward you.



Note

- Sew while holding the fabric stretched in order to keep the fabric held down.

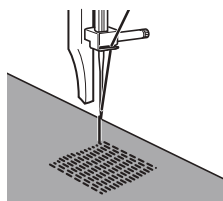
- Repeat this motion until the section being darned is filled with parallel lines of stitching.



Appliqués

Stitch Name	Pattern	Stitch Length [mm (inch)]	Stitch Width [mm (inch)]
Zigzag Stitch		F-2 (1/64-1/16)	1.5 (1/16)
Zigzag Stitch		F-2 (1/64-1/16)	3.5 (1/8)
Zigzag Stitch		F-2 (1/64-1/16)	5 (3/16)

You can create an appliqué by cutting a different piece of fabric into a shape and applying it as a decoration.

5 Place the fabric under the foot so the foot guide is aligned between both edges of the fabric.

6 Lower the presser foot and start sewing.

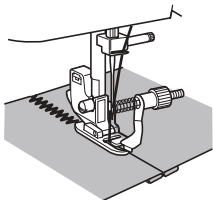

■ **When stretch blind hem stitching**

When stretch blind hem stitching using the blind stitch foot, turn the screw to adjust the guide to the folded hem.

- For more details on blind hem stitching, see page 27.

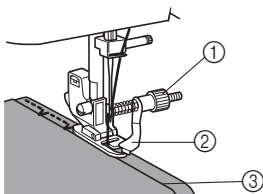

- ① Screw
- ② Guide
- ③ Folded hem

6 APPENDIX

MAINTENANCE

Restrictions on oiling

In order to prevent damaging this machine, it must not be oiled by the user.

This machine was manufactured with the necessary amount of oil applied to ensure correct operation, making periodic oiling unnecessary.

If problems occur, such as difficulty turning the handwheel or an unusual noise, immediately stop using the machine, and contact your authorized dealer or the nearest authorized service center.

Precautions on storing the machine

Do not store the machine in any of the locations described below, otherwise damage to the machine may result, for example, rust caused by condensation.

- Exposed to extremely high temperatures
- Exposed to extremely low temperatures
- Exposed to extreme temperature changes
- Exposed to high humidity or steam
- Near a flame, heater or air conditioner
- Outdoors or exposed to direct sunlight
- Exposed to extremely dusty or oily environments



Note

- In order to extend the life of this machine, periodically turn it on and use it. Storing this machine for an extended period of time without using it may reduce its efficiency.

Cleaning

CAUTION

- Make sure you unplug the machine before you clean it, otherwise you risk getting an electric shock or being injured.

- 1 Turn off the machine and unplug it.
- 2 Raise the needle and the presser foot.
- 3 Loosen the presser foot screw and the needle clamp screw to remove the presser foot holder and the needle.

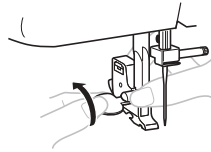

- 4 Using the oval screwdriver, remove the two screws. Lift up the needle plate as shown in the illustration, and then slide the needle plate to the left to remove it.

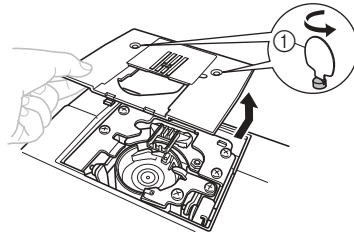

- 5 Grasp the bobbin case, and then lift it out to the left.

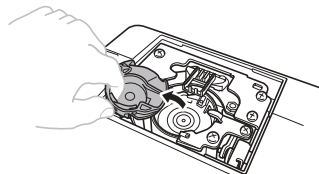

- 6** Use the cleaning brush or a vacuum cleaner to remove any dust from the race and its surrounding area.

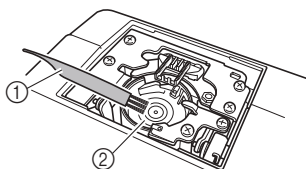

- ① Cleaning brush
② Race

- Do not apply oil to the bobbin case.

- 7** Insert the bobbin case so that the ▲ mark on the bobbin case aligns with the ● mark on machine as shown below.

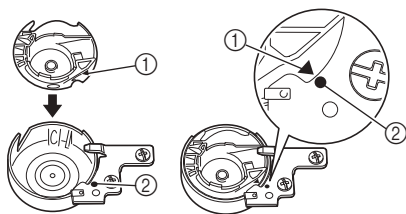

- Align the ▲ and ● marks.

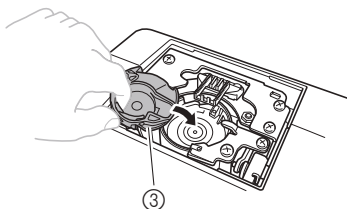

- ① ▲ mark
② ● mark
③ Bobbin case

- Make sure that the indicated points are aligned before installing the bobbin case.

- 8** Install the needle plate, and then tighten the screws.

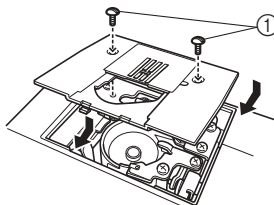

- ① Screws

- Make sure that you install the needle plate securely.

! CAUTION

- Never use a bobbin case that is scratched; otherwise the upper thread may become tangled, the needle may break, or sewing performance may suffer. For a new bobbin case (part code: XE9326-001), contact your nearest authorized service center.
- Make sure that you fit the bobbin case properly, otherwise the needle may break.

TROUBLESHOOTING

If the machine stops operating correctly, check the following possible problems before requesting service. You can solve most problems by yourself. If you need additional help, the Brother Solutions Center offers the latest FAQs and troubleshooting tips. Visit us at “ <http://support.brother.com/> “. If the problem persists, contact your dealer or the nearest authorized service center.

Symptom	Possible cause	How to put it right	Page
The sewing machine does not work.	The main power switch is turned off.	Turn on the main power switch.	7
	The bobbin-winder shaft is pushed to the right.	Move the bobbin-winder shaft to the left.	13
	You have not used the foot controller properly.	Use the foot controller properly.	7
Fabric being sewn with the machine cannot be removed.	Thread is tangled below the needle plate.	Lift up the fabric and cut the threads below it, and clean the race.	40
The needle breaks.	The needle is incorrectly installed.	Correctly install the needle.	7
	The needle clamp screw is loose.	Use the oval screwdriver to firmly tighten the screw.	8
	The needle is bent or blunt.	Replace the needle.	7
	The upper thread was not threaded correctly.	Correct the upper threading.	16
	You have not used the right combination of fabric, thread and needle.	Choose a thread and needle that are appropriate for the type of fabric.	21
	The presser foot you are using is not appropriate for the type of stitch that you want to sew.	Attach the presser foot that is correct for the type of stitch that you want to sew.	–
	The upper thread tension is too tight.	Loosen the upper thread tension.	26
	You are pulling the fabric too much.	Lightly guide the fabric.	–
	You have not fitted the spool properly.	Fit the spool properly.	16, 24
	The area around the hole in the needle plate or the presser foot is scratched.	Replace the needle plate. Contact your retailer or the nearest authorized service center.	–
	The bobbin case is scratched.	Replace the bobbin case. Contact your retailer or the nearest authorized service center.	–
	You have not used a bobbin that has been designed for this machine.	Use a bobbin that has been designed for this machine.	12
The upper thread breaks.	You have not threaded the upper thread properly. (For example, you have not fitted the spool properly, or the thread has come out of the guide above the needle.)	Correct the upper threading.	16
	There are knots or tangles in the thread.	Remove any knots or tangles.	–
	The needle is not appropriate for the thread you are using.	Choose a needle that is appropriate for the type of stitch.	21
	▼ The upper thread tension is too tight.	Loosen the upper thread tension.	26

Symptom	Possible cause	How to put it right	Page
▲ The upper thread breaks.	The needle is bent or blunt.	Replace the needle.	7
	The needle is incorrectly installed.	Correctly install the needle.	7
	The area around the hole in the needle plate or the presser foot is scratched.	Replace the needle plate. Contact your retailer or the nearest authorized service center.	–
	The bobbin case is scratched, or has a burr on it.	Replace the bobbin case. Contact your retailer or the nearest authorized service center.	–
	You have not used a bobbin that has been designed for this machine.	Use a bobbin that has been designed for this machine.	12
The lower thread is tangled or breaks.	You have not wound the bobbin thread properly.	Wind the bobbin thread properly.	12
	The bobbin is scratched or does not turn smoothly.	Replace the bobbin.	–
	The thread is tangled.	Remove the tangled thread and clean the race.	40
	You have not used a bobbin that has been designed for this machine.	Use a bobbin that has been designed for this machine.	12
	Bobbin is set incorrectly.	Reset the bobbin thread correctly.	14-15
▲ The thread tension is incorrect.	You have not threaded the upper thread properly.	Correct the upper threading.	16
	You have not wound the bobbin thread properly.	Wind the bobbin thread properly.	12
	You have not threaded the right combination of thread and needle for the fabric you are using.	Choose a thread and needle that are appropriate for the type of fabric.	21
	You have not attached the presser foot holder properly.	Attach the presser foot holder properly.	–
	The thread tension is incorrect.	Adjust the tension of the upper thread.	26
	You have not used a bobbin that has been designed for this machine.	Use a bobbin that has been designed for this machine.	12
	Bobbin is set incorrectly.	Reset the bobbin thread correctly.	14-15
▼ The fabric is wrinkled.	You have not threaded the upper thread properly or fitted the bobbin properly.	Thread the upper thread and wind the bobbin thread properly.	12-19
	You have not fitted the spool properly.	Fit the spool properly.	16, 24
	You have not used the right combination of fabric, thread and needle.	Choose a thread and needle that are appropriate for the type of fabric.	21
	The needle is bent or blunt.	Replace the needle.	7
	If thin fabrics are being sewn, the fabric is not being fed correctly.	Sew with stabilizer material under the fabric.	24
	If thin fabrics are being sewn, the stitch is too coarse.	Shorten the stitch length.	11
	The presser foot you are using is not appropriate for the type of stitch that you want to sew.	Attach the presser foot that is correct for the type of stitch that you want to sew.	36

Symptom	Possible cause	How to put it right	Page
▲ The fabric is wrinkled.	The thread tension is incorrect.	Adjust the tension of the upper thread.	26
Stitches are skipped.	You have not threaded the upper thread properly.	Correct the upper threading.	16
	You have not used the right combination of fabric, thread and needle.	Choose a thread and needle that are appropriate for the type of fabric.	21
	The needle is bent or blunt.	Replace the needle.	7
	The needle is incorrectly installed.	Correctly install the needle.	7
	Dust has accumulated under the needle plate or in the bobbin case.	Remove the needle plate and clean the plate and the bobbin case.	40
The needle threader can not be used.	The needle has not been raised to the correct position.	Raise the needle by turning the handwheel toward you (counterclockwise) so that the mark on the wheel points up.	18
	You have not inserted the needle properly.	Insert the needle properly.	7
The stitch is not sewn correctly.	The presser foot that you are using is not correct for the type of stitch.	Attach the presser foot that is correct for the type of stitch that you want to sew.	–
	The thread tension is incorrect.	Adjust the tension of the upper thread.	26
	The thread is tangled.	Remove the tangled thread. If the thread is tangled in the bobbin case, clean the bobbin case.	40
The fabric does not feed.	The stitch is too fine.	Lengthen the stitch length.	–
	The darning plate is fitted on the needle plate.	Remove the darning plate.	–
	You have not used the right combination of fabric, thread and needle.	Choose a thread and needle that are appropriate for the type of fabric.	21
	The thread is tangled, for example, in the race.	Remove the tangle thread. If the thread is tangled in the race, clean the race.	40
	The presser foot you are using is not appropriate for the type of stitch that you want to sew.	Attach the presser foot that is correct for the type of stitch that you want to sew.	36

INDEX

Numerics

4-Step Automatic Buttonhole 33

A

Accessories 4

 optional 4, 38

Appliqués 37

B

Blind hem stitching 27

Blind stitch foot 38

Bobbin winding 12

Button sewing 35

Buttonhole

 adjusting 34

 making 33

Buttonhole fine-adjustment screw 34

C

Cleaning 40

Connecting plugs 6

D

Darning 37

Darning plate 35, 37

Decorative stitching 32

Double action stitching 30

Drawing up the lower thread 19

E

Elastic stitching 29

F

Fabric, thread, and needle combinations 21

Fagoting 30

Feather stitching 31

Flat bed attachment 5

Foot controller 7

Free-arm style 24

G

Gathering 37

H

Handwheel 16

L

Light switch 7

Lower threading 14

 quick-set bobbin 15, 20

M

Main parts 5

Main power 7

Maintenance 40

N

Needle

 checking 7

 combinations with fabric and thread 21

 replacing 7

Needle threader 18

O

Overedge stitching 31

P

Pattern selection dial 9

Patterns 10

Presser foot changing 8

Q

Quick-set bobbin 15, 20

R

Race cleaning 40

Reverse sewing lever 11

S

Satin stitch 27

Shell tuck stitching 29

Spool pin 12, 16

 extra 25

Stitch length dial 11

Stitches

 built-in 27

 names 10

 Straight stitching 27

 Stretch stitching 9

T

Thread cutter 23

Thread tension 26

Threading

 lower 14, 15

 needle threader 18

 twin needle 25

 upper 16

Triple zigzag stretch stitching 32

Troubleshooting 42

Twin needle

 attaching 8, 24

 sewing 24

U

Upper tension control dial 26

Upper threading 16

Z

Zigzag stitching 27

Zipper insertion 36

Please visit us at <http://support.brother.com/> where you can get product support and answers to frequently asked questions (FAQs).

English
888-X03/X13/X23
Printed in Vietnam



XF0501-201③